

Schnelleinsatzkran

Self-erecting crane / Grue à montage rapide /
Gru a montaggio rapido







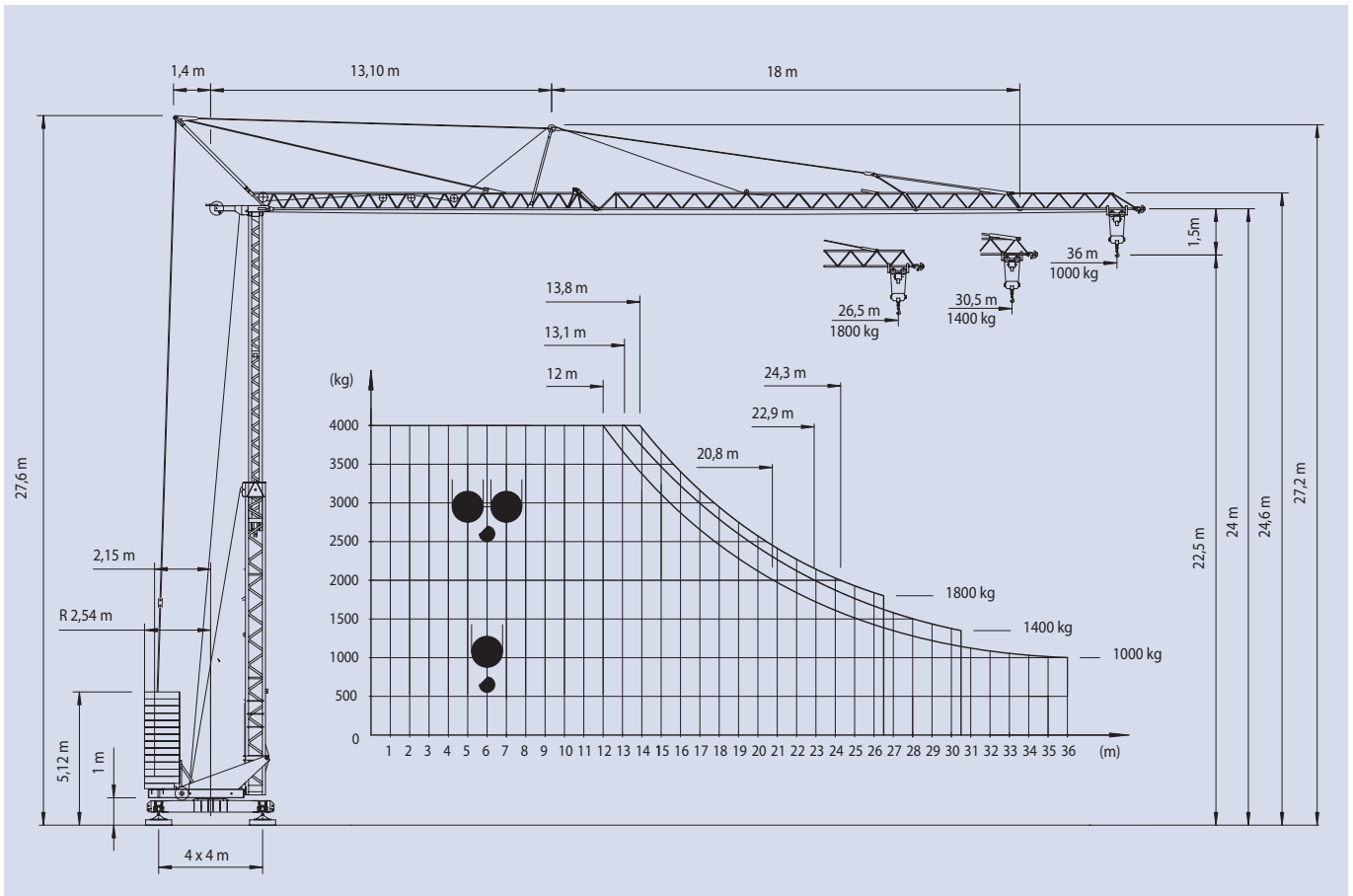



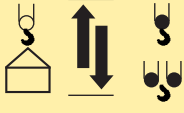

EURO 3610

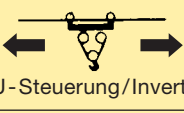

EURO 3610



Ausleger in Horizontalstellung / Jib in horizontal position / Flèche horizontale / Braccio orizzontale

Tragkraft / Capacity / Charge / Pesi	kg	4000	2000	1800	1400	1000
 26,5 m	m	13,8	24,3	26,5		
 30,5 m	m	13,1	22,9		30,5	
 36,0 m	m	12,0	20,8			36,0
 FU-Steuerung/Inverter		50 m/min	1400 kg			
		25 m/min	2000 kg			
		6,2 m/min	2000 kg			
 FU-Steuerung/Inverter		25 m/min	2800 kg			
		12,5 m/min	4000 kg			
		3,1 m/min	4000 kg			
 FU-Steuerung/Inverter		15-30-60 m/min				
 FU-Steuerung/Inverter		0,2-0,6-0,9 1/min				

Hakenhöhe
height under hook 17,5 m
hauteur s/crochet 22,5 m
altezza al gancio

Abstützung
base dimension 4,0 x 4,0 m
ecartement de voie
scartamento

Drehradius
slewing radius 2,54 m
rayon de giration arrière
raggio di rotazione

Konstruktionsgewicht
dead weight 13,5 t
poids de la grue
peso della gru

Gegenballast
counter weight 27 t
contre poids
zavorra contrappeso

Eckdruck
ground pressure max. 24 t
pression d'angle
pressione su stabilizzatore

Gesamt - Motorenleistung
total motor output 23 kW
puissance totale des moteurs
forza motrice totale

Kabelquerschnitt
cross section of cable 4 x 16 mm²
section du cable
sezione del cavo sottogomma

EURO 3610

Montageablauf / Erection procedure / Descriptif de montage / Diagramma di montaggio

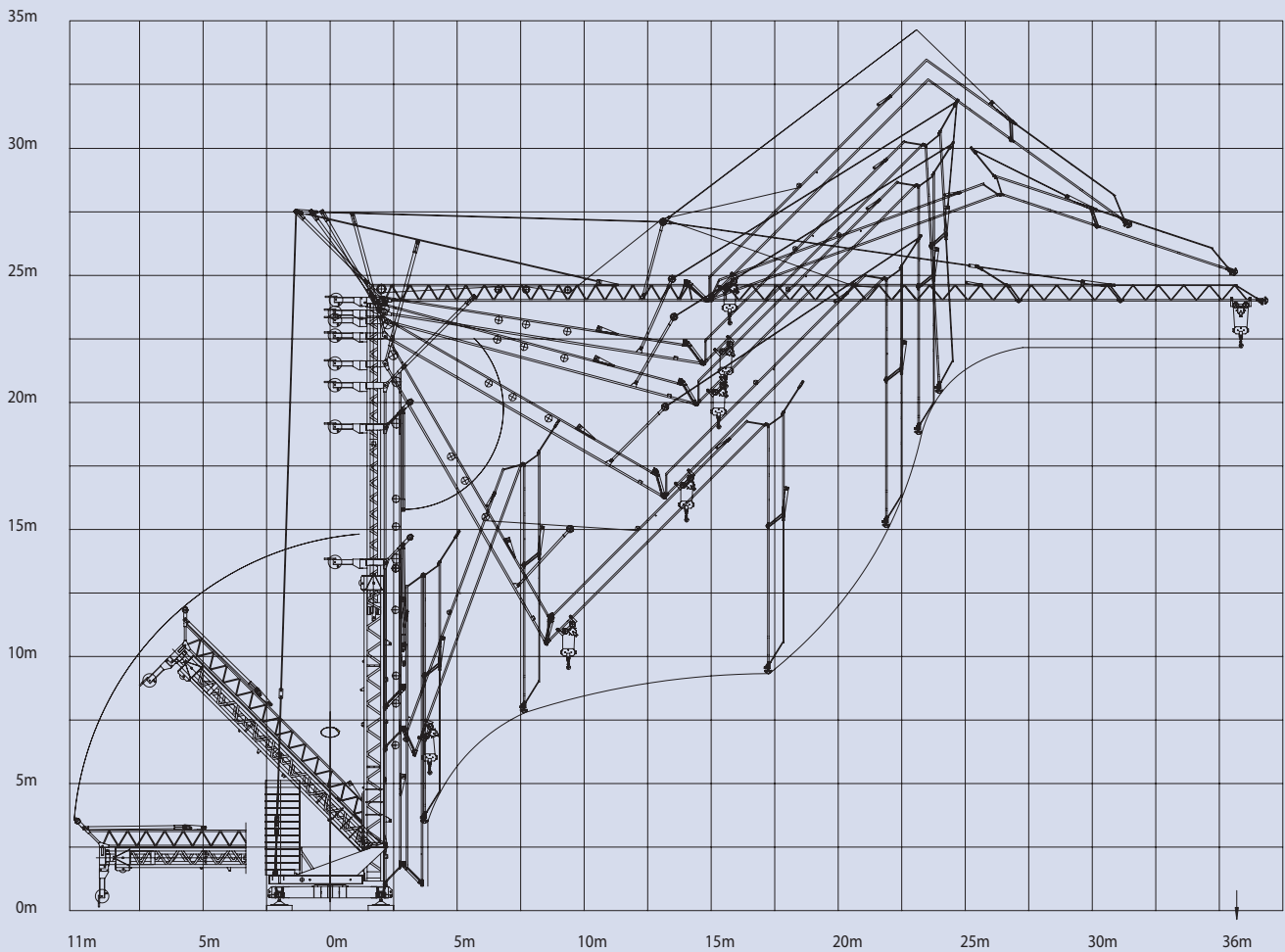

 Richtlinie 2000/14 EG
für den Schall-Leistungspegel

Instruction EC 2000/14
on noise level

Directive CE 2000/14
sur le niveau acoustique

Direttive CE 2000/14
sul livello acustico

Transport / Transport / Transport / Trasporto

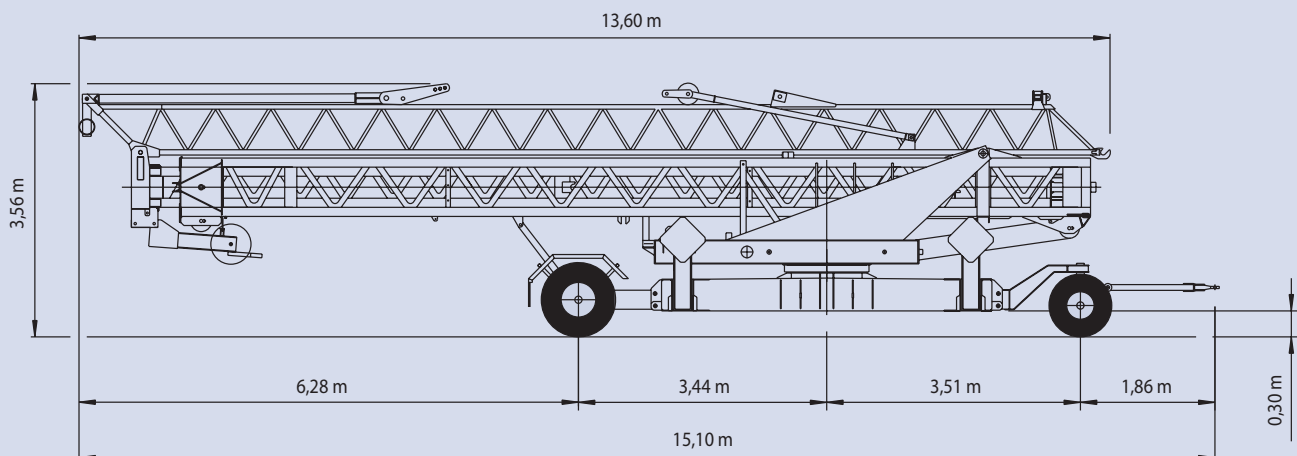



Conducta AG
Stegackerstrasse 6
CH-8409 Winterthur
Telefon +41 (0)52 234 51 51
Fax +41 (0)52 234 51 50
info@conducta.ch
www.conducta.ch

Conducta (Romandie) SA
Ch. de la Clopette 30
CH-1040 Echallens
Téléphone 021 869 04 04
Fax 021 869 04 00
contact@conducta.ch
www.conducta.ch

Werner Fercher AG
CH-3931 Lalden VS
Telefon 027 946 40 21
Fax 027 946 31 63

Macchimport SA
CH-6804 Bironico TI
Telefono 091 946 10 71
Fax 091 946 27 76

Conducta GmbH
Breitenbachstrasse 1
D-82538 Geretsried 1
Telefon +49 (0)81 71 2196-0
Fax +49 (0)81 71 2196-66
info@conducta.de
www.conducta.de

Conducta S.p.A.
Macchine Edili
Via Liguria 11 A
I-36015 Schio (VI)
Telefono +39 0445 576229
Fax +39 0445 575320
www.conducta.it